

Varenummer: 390204900702336  
 Beskrivelse: Snekkegear med skridnav  
 VF 49-L2-U-7 P63B14

## Mål

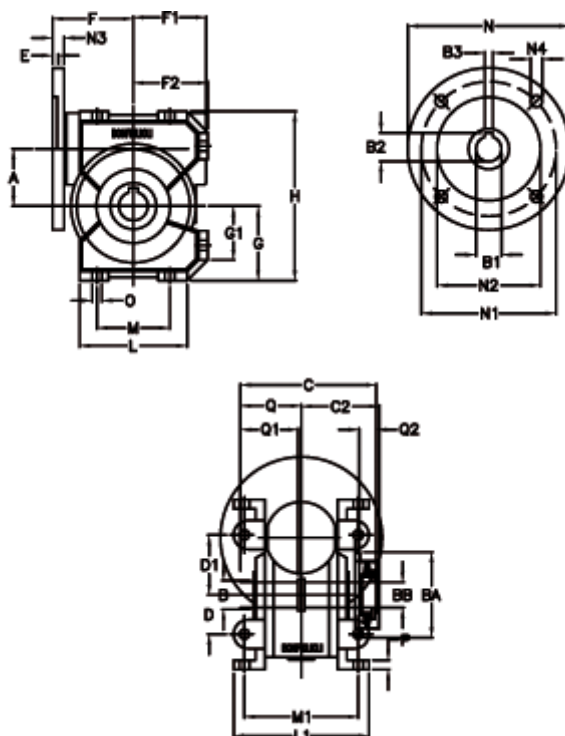

a	= 49.5	C	= 105	g	= 64.5	N	= 90	Q1	= 41
B	= 25	C2	= 63.5	G1	= 46.5	N1	= 75	Q2	= 15
B1 E7	= 11	D	= 34	H	= 146.5	N2	= 60		
B2	= 12.8	D1	= 52	H1	= 110.5	N3	= 7.0		
B3 H9	= 4	E	= 3.0	L	= 93	N4	= 6.0		
BA	= 63	F	= 70	L1	= 117	O	= 8.5		
BB H7	= 14	F1	= 63	m	= 63	P	= 8		
Betegnelse = VF 49U-xx-63B14		F2	= 64.5	M1	= 98.5	Q	= 51.0		